

SDS

Submersible borehole pumps for 6", 8" and 10" wells

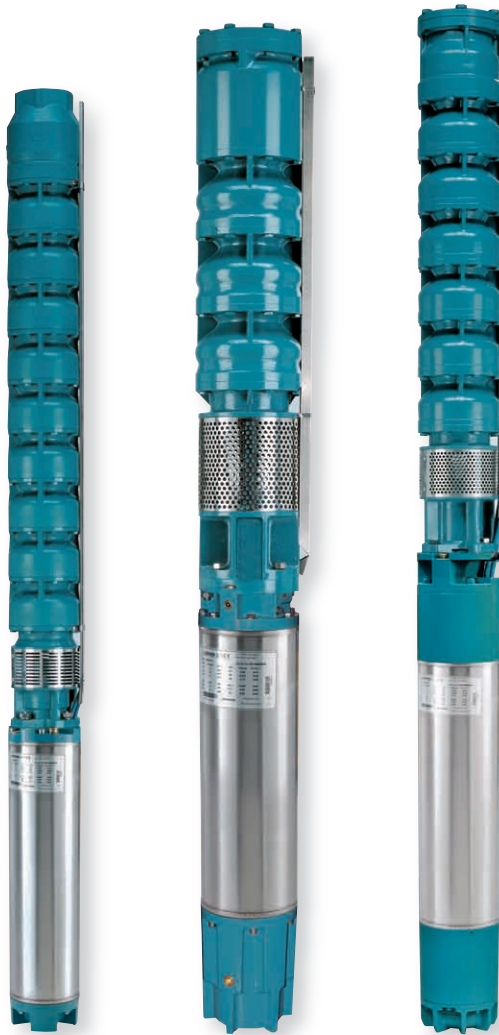

Construction

Submersible borehole pumps for 6" wells (DN 150 mm), 8" (DN 200 mm) and 10" (DN 250 mm), with stages in cast iron or in bronze, on request.

Impellers: - mixed flow impellers.

Connection: - screwed connection ISO 228 for 6SDS;
- flange with counter-flange for welding for 8SDS and 10SDS

Delivery casing with built-in non-return valve.

Applications

For water supply.
For civil and industrial applications.
For fire fighting applications.
For irrigation.

Operating conditions

Liquid temperature up to a 25 °C.
Max. sand quantity into the water: 150 g/m³ (300 g/m³ high percentage of solids and sand).
Continuous duty.

Rewindable motor CS, CS-R series

2-pole induction motor, 50 Hz (n ≈ 2900 rpm).
With water wetted winding in rewindable execution.
Sized for connection to the pumps according to NEMA Standards.
Standard voltages:
- three-phase 400 V; 400/690 V.
Voltage tolerance : +6% / -10%.

In order to limit both current and torque at each starting, for rated motor powers equal to or higher than 7.5kW, one of the following types of starting is necessary: star/delta, soft starter, stator impedance or autotransformer.

Operating conditions motor

Motor	Max. Liquid temperature	Cooling: minimum flow velocity	Max. starts per hour	Motor P2
6CS-R	30 °C	0,1 m/s	15	4÷11 kW
		0,2 m/s	15	13÷15 kW
	25 °C	0,2 m/s	15	18,5 kW
		0,2 m/s	13	22÷30 kW
40 °C	0,1 m/s	13	37 kW	
	0,3 m/s	6	45 kW	
	0,3 m/s	10	30÷45 kW	
8CS-R	25 °C	0,3 m/s	8	51÷75 kW
			6	92 kW
			10CS	25 °C

Insulation class E for 6-8" motors, PVC coated wire for 10" motors.

Motor suitable operation with frequency converter.
Protection IP 68.

Special features on request

- Other voltages.
- 60 Hz frequency.
- Other temperatures.
- Encapsulated motor **FK series**.

Designation

B 10 SDS 190 / 6

Bronze construction (on request)

Ø of the well in inches _____

Series _____

Stage identification _____

Number of stages _____

Materials

Components	Part Nr.	6, 8, 10SDS	B-6, B-8, B-10SDS
Stage casing	25.02	Cast iron GJL 200 EN 1561	Bronze G-Cu Sn 10 EN 1982
Diffuser	26.00		
Impeller	28.00		
Wear ring		Rubber (Bronze for 10SDS 190-280)	
Shaft	64.00	Steel AISI F51duplex	
Shaft sleeve	64.08	Brass with chromate surface treatment (only for 10SDS)	
Delivery casing	12.01	Cast iron GJL 200 EN 1561	Bronze G-Cu Sn 10 EN 1982
Suction lantern	32.02		
Bearing bush	12.03-12.30	Rubber	
Strainer	15.50	Cr-Ni steel AISI 304	
Screws		Cr-Ni steel AISI 304	

CS, CS-R Motor

Components	CS-R 6", 8", CS 10" standard	I-CS-R 6", 8", I-CS 10" AISI 316
External frame	AISI 304 (AISI 316Ti for 10")	Cr-Ni-Mo steel AISI 316 Ti
Motor flange	Cast iron GJL 200 EN 1561	Cr-Ni-Mo steel AISI 316
Shaft end	Steel AISI 431 (AISI 329 for 10")	AISI 316 (AISI 630 from 30 to 93kW) (AISI 429 for 10")
Thrust bearing	Oscillating pads	Oscillating pads
Bushings	Graphite (Bronze for 8" motor)	Graphite (Bronze for 8" motor)

SDS

Submersible borehole pumps for 6", 8" and 10" wells



Coverage chart $n \approx 2900$ rpm

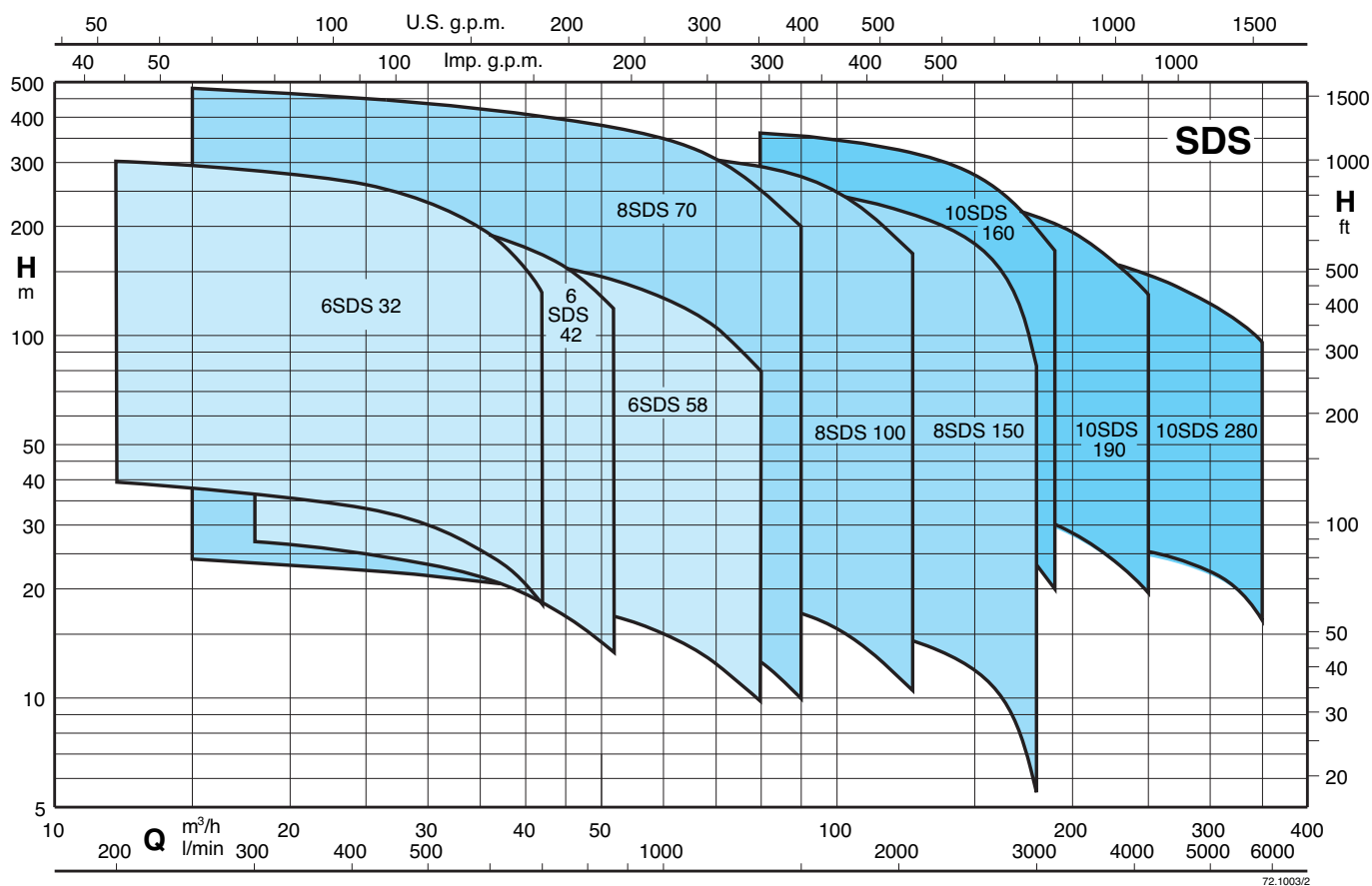

6SDS 32

Submersible borehole pumps for 6" wells



Characteristic curves, performance $n \approx 2900$ rpm, dimensions and weights

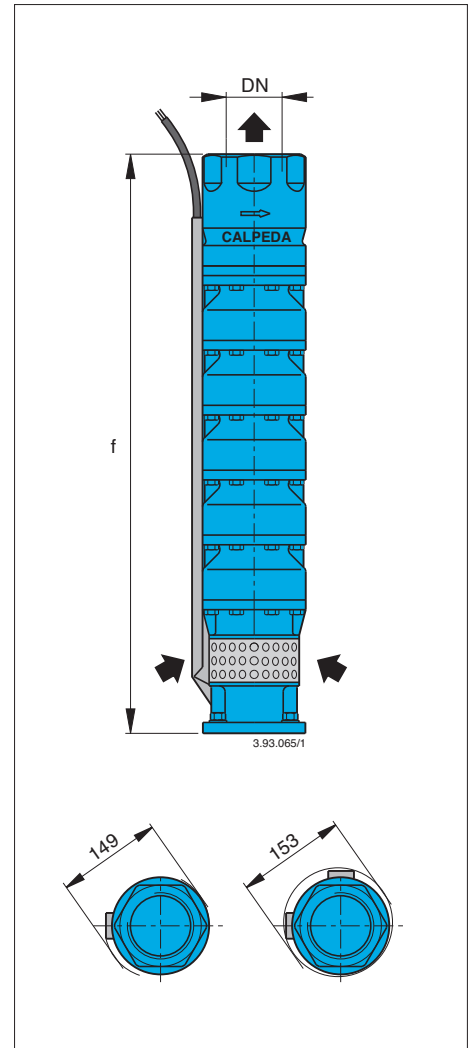
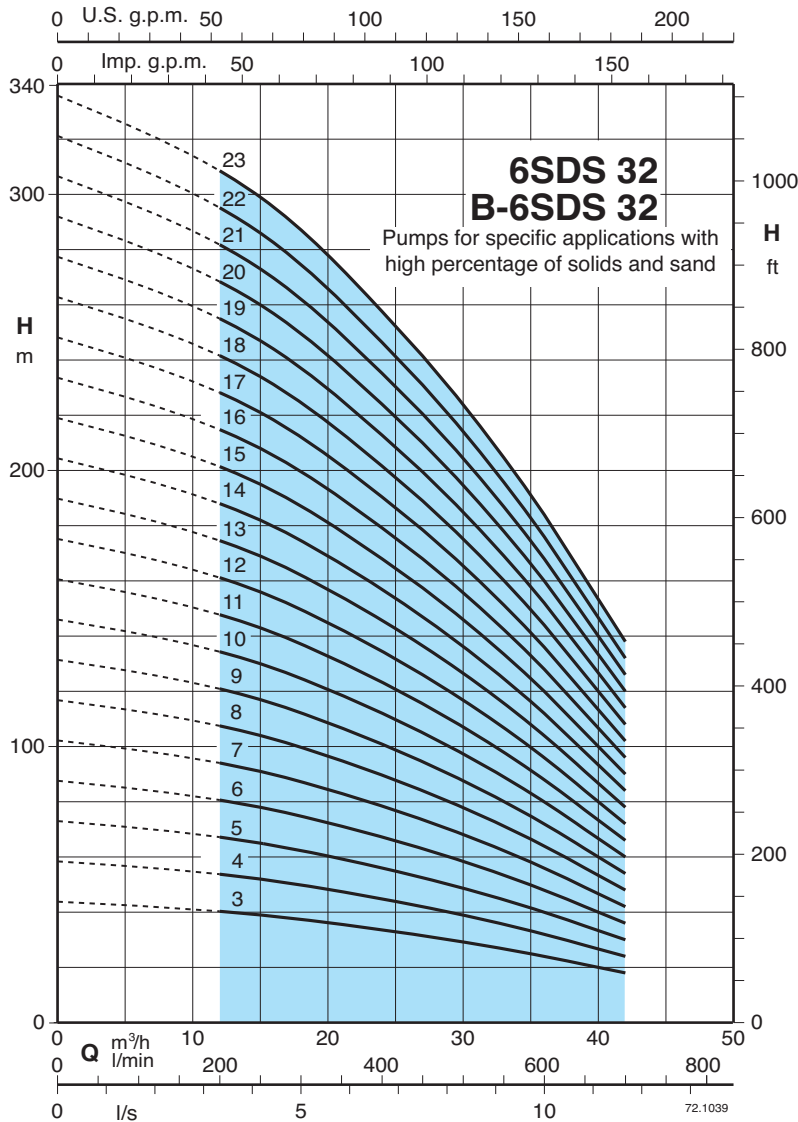

3 ~	P ₂		Q	n ≈ 2900 rpm											
	kW	HP		H (m)											
				12	18	21	24	27	30	33	36	39	42		
6SDS 32/3 - B-6SDS 32/3	4	5,5	39	37	35,5	33,5	31,5	30	26,5	24	21	18			
6SDS 32/4 - B-6SDS 32/4	5,5	7,5	52	49	47	45	42	39,5	35,5	32	28	24			
6SDS 32/5 - B-6SDS 32/5	7,5	10	65	61,5	59	56	52,5	49,5	44,5	40	35	30			
6SDS 32/6 - B-6SDS 32/6	7,5	10	78	74	71	67	63	59,5	53,5	48	42	36			
6SDS 32/7 - B-6SDS 32/7	9,2	12,5	92	86	82,5	78,5	73,5	69	62	56	49	42			
6SDS 32/8 - B-6SDS 32/8	11	15	105	98,5	94,5	89,5	84	79	71	64	56	48			
6SDS 32/9 - B-6SDS 32/9	13 (15)	17,5 (20)	118	111	106	101	94,5	89	80	72	63	54			
6SDS 32/10 - B-6SDS 32/10	13 (15)	17,5 (20)	131	123	118	112	105	99	89	80	70	60			
6SDS 32/11 - B-6SDS 32/11	15	20	144	135	130	123	115	109	98	88	77	66			
6SDS 32/12 - B-6SDS 32/12	15	20	157	147	141	134	126	119	107	96	84	72			
6SDS 32/13 - B-6SDS 32/13	18,5	25	170	160	153	145	136	129	116	104	91	78			
6SDS 32/14 - B-6SDS 32/14	18,5	25	183	172	165	157	147	138	124	112	98	84			
6SDS 32/15 - B-6SDS 32/15	22	30	196	184	177	168	157	148	133	120	105	90			
6SDS 32/16 - B-6SDS 32/16	22	30	209	197	189	179	168	158	142	128	112	96			
6SDS 32/17 - B-6SDS 32/17	22	30	223	209	200	190	178	168	151	136	119	102			
6SDS 32/18 - B-6SDS 32/18	26 (30)	35 (40)	236	221	212	201	189	178	160	144	126	108			
6SDS 32/19 - B-6SDS 32/19	26 (30)	35 (40)	246	234	224	213	199	188	169	152	133	114			
6SDS 32/20 - B-6SDS 32/20	26 (30)	35 (40)	262	246	236	224	210	198	178	160	140	120			
6SDS 32/21 - B-6SDS 32/21	26 (30)	35 (40)	275	258	248	235	220	208	187	168	147	126			
6SDS 32/22 - B-6SDS 32/22	30	40	288	270	259	246	231	218	196	176	154	132			
6SDS 32/23 - B-6SDS 32/23	30	40	301	283	271	257	241	228	205	184	161	138			

DN	f	6SDS	B-6SDS
	mm	kg	kg
G 3 ISO 228	686	30,5	35,5
	788	35,6	41,6
	890	41	49
	992	46	55
	1094	52,3	62,3
	1196	57	68
	1298	62,5	74,5
	1400	68,5	81,5
	1502	72,5	86,5
	1604	77,5	93,5
	1706	84	101
	1808	89	108
	1910	94,2	112
	2012	100	119
	2114	105	125
	2216	111	132
2318	116	139	
2420	122	145	
2522	127	151	
2624	132	157	
2726	137	164	

P₂ Rated motor power output

(...) FK motor rated power output

H Total head in m

Tolerances according to UNI EN ISO 9906:2012

6SDS 42

Submersible borehole pumps for 6" wells



Characteristic curves, performance $n \approx 2900$ rpm, dimensions and weights

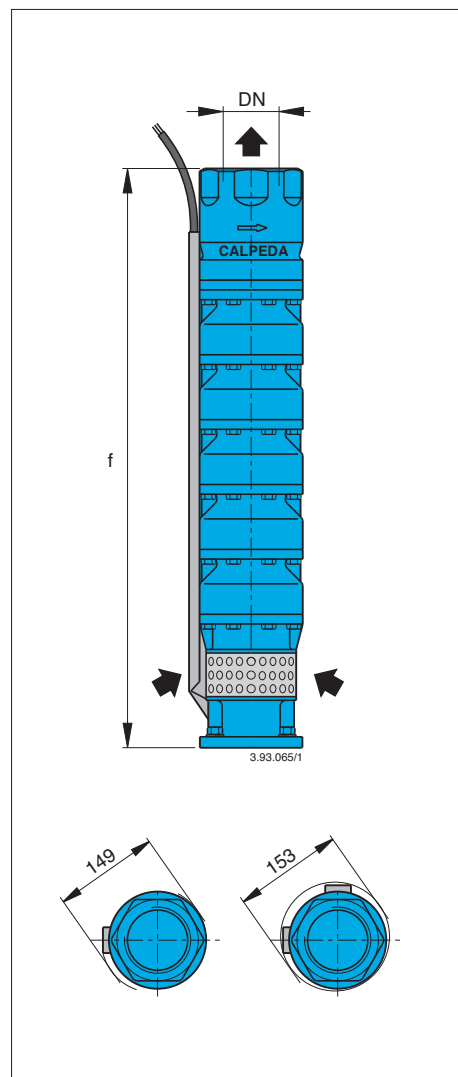
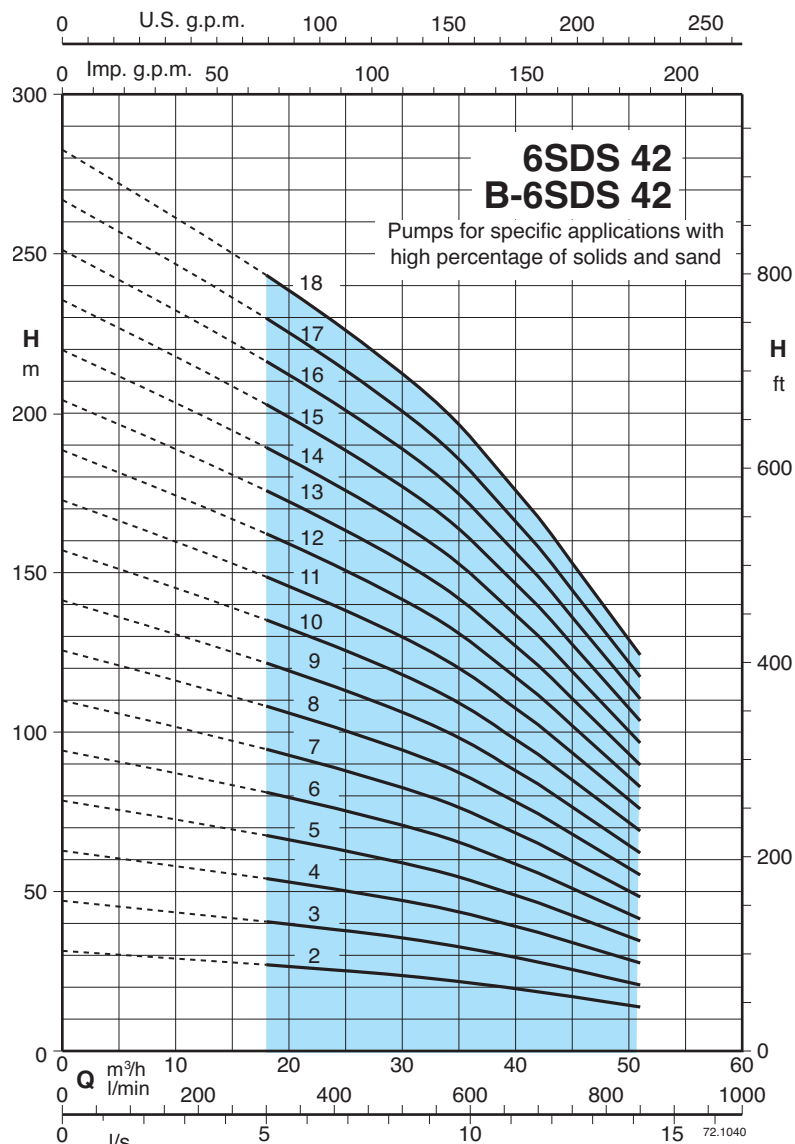

3 ~	P ₂		Q	n ≈ 2900 rpm											
	kW	HP		H											
				m											
			m³/h	18	24	30	33	36	39	42	45	48	51		
			l/min	300	400	500	550	600	650	700	750	800	850		
6SDS 42/2 - B-6SDS 42/2	4	5,5		27	25,5	23,5	22,5	21,5	20	18,5	17	15,5	14		
6SDS 42/3 - B-6SDS 42/3	5,5	7,5		40	38	35,5	34	32	30	28	25,5	23	21		
6SDS 42/4 - B-6SDS 42/4	7,5	10		53,5	51	47	45	43	40	37	34	31	27,5		
6SDS 42/5 - B-6SDS 42/5	9,2	12,5		67	63,5	59	56,5	53,5	50	46,5	42,5	38,5	34,5		
6SDS 42/6 - B-6SDS 42/6	11	15		80,5	76	71	68	64	60	56	51	46	41,5		
6SDS 42/7 - B-6SDS 42/7	13 (15)	17,5 (20)		94	89	82,5	79	75	70	65	59,5	54	48		
6SDS 42/8 - B-6SDS 42/8	15	20		107	101	94,5	90,5	85,5	80	74,5	68	61,5	55		
6SDS 42/9 - B-6SDS 42/9	15	20		120	114	106	102	96	90	84	76,5	69	62		
6SDS 42/10 - B-6SDS 42/10	18,5	25		134	127	118	113	107	100	93	85	77	69		
6SDS 42/11 - B-6SDS 42/11	18,5	25		147	140	130	124	118	110	102	93,5	85	76		
6SDS 42/12 - B-6SDS 42/12	22	30		161	152	141	135	128	120	111	102	92,5	83		
6SDS 42/13 - B-6SDS 42/13	22	30		174	165	153	147	139	130	121	110	100	90		
6SDS 42/14 - B-6SDS 42/14	26 (30)	35 (40)		187	178	165	158	150	140	130	119	108	96,5		
6SDS 42/15 - B-6SDS 42/15	26 (30)	35 (40)		201	190	177	169	160	150	139	127	115	103		
6SDS 42/16 - B-6SDS 42/16	30	40		214	203	189	181	171	160	149	136	123	110		
6SDS 42/17 - B-6SDS 42/17	30	40		228	216	200	192	182	170	158	144	131	117		
6SDS 42/18 - B-6SDS 42/18	30	40		241	228	212	203	192	180	167	153	138	124		

DN	f	6SDS	B-6SDS
	mm	kg	kg
G 3 ISO 228	584	25,5	29,5
	686	31,6	36,6
	788	36	42
	890	40,3	48,3
	992	47	59
	1094	50,5	65,5
	1196	55,5	66,5
	1298	62,5	74,5
	1400	69	81
	1502	74	86
	1604	79,2	94,2
	1706	83,2	99,2
	1808	91,4	106
	1910	96,4	113
2012	101	119	
2114	106	126	
2216	111	132	

P₂ Rated motor power output

(...) FK motor rated power output

H Total head in m

Tolerances according to UNI EN ISO 9906:2012

6SDS 58

Submersible borehole pumps for 6" wells



Characteristic curves, performance $n \approx 2900$ rpm, dimensions and weights

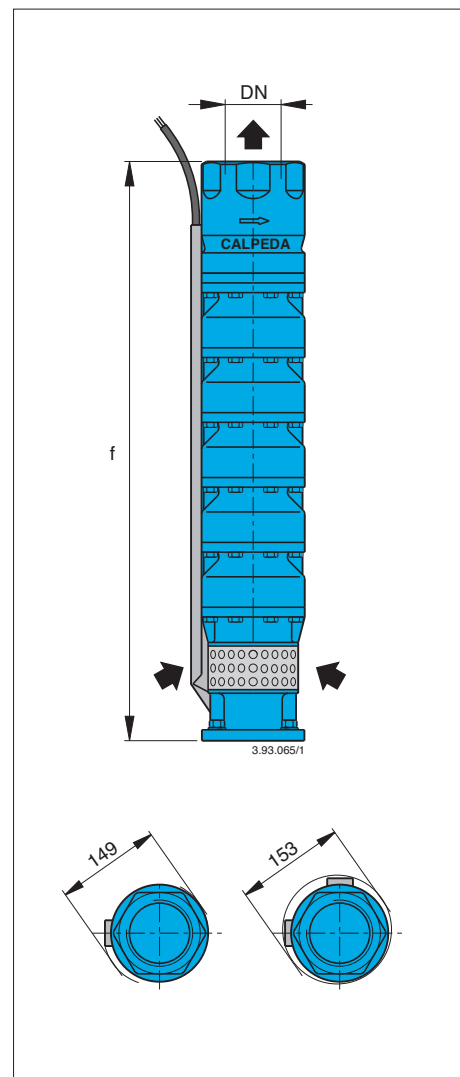
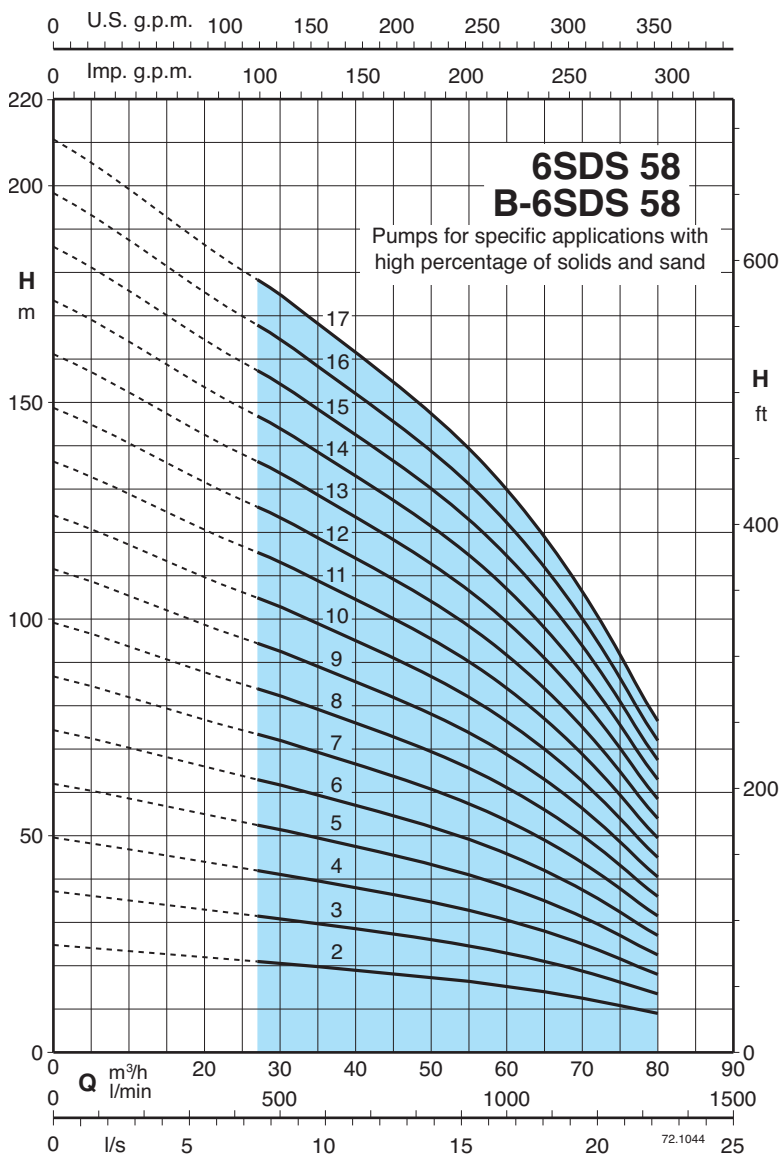

3 ~	P ₂		Q	n ≈ 2900 rpm											
	kW	HP		H											
				m³/h	27	35	40	45	50	55	60	65	70	75	80
6SDS 58/2 - B-6SDS 58/2	4	5,5	l/min	450	583	666	750	833	916	1000	1083	1166	1250	1333	
6SDS 58/3 - B-6SDS 58/3	5,5	7,5	H m	21	20	19	18	17	16,5	15,5	14	12,5	11	9	
6SDS 58/4 - B-6SDS 58/4	7,5	10		32	30	28,5	27	26	24,5	23	21	18,5	16	13,5	
6SDS 58/5 - B-6SDS 58/5	9,2	12,5		42,5	39,5	38	36	34,5	33	31	28	25	21,5	18	
6SDS 58/6 - B-6SDS 58/6	11	15		53	49,5	47,5	45	43	41	38,5	35	31	27	22,5	
6SDS 58/7 - B-6SDS 58/7	13 (15)	17,5 (20)		63,5	59,5	57	54	51,5	49	46	42	37	32,5	27	
6SDS 58/8 - B-6SDS 58/8	15	20		74	69,5	66,5	63	60	57,5	54	49	43,5	38	31,5	
6SDS 58/9 - B-6SDS 58/9	18,5	25		85	79	76	72	69	66	62	56	49,5	43	36	
6SDS 58/10 - B-6SDS 58/10	18,5	25		95,5	89	85,5	81	77,5	74	69,5	63	56	49	40,5	
6SDS 58/11 - B-6SDS 58/11	22	30		106	99	95	90	86	82	77	70	62	54	45	
6SDS 58/12 - B-6SDS 58/12	22	30		117	109	104	99	94,5	90	85	77	68	59,5	49,5	
6SDS 58/13 - B-6SDS 58/13	26 (30)	35 (40)		127	119	114	108	103	100	94,5	86,5	76,5	66,5	55,5	
6SDS 58/14 - B-6SDS 58/14	26 (30)	35 (40)		138	129	123	117	112	107	100	91	80,5	70	58,5	
6SDS 58/15 - B-6SDS 58/15	30	40		148	139	133	126	120	115	108	98	87	75,5	63	
6SDS 58/16 - B-6SDS 58/16	30	40		159	148	142	135	129	123	115	105	93	81	67,5	
6SDS 58/17 - B-6SDS 58/17	30	40		170	158	152	144	138	131	123	112	99	86,5	72	
					180	168	162	153	146	139	131	119	105	92	76,5

DN	f	6SDS	B-6SDS
	mm	kg	kg
G 4 ISO 228	584	26,5	29,5
	686	31,6	36,6
	788	37	43
	890	43,3	50,3
	992	48	57
	1094	53,5	63,5
	1196	59,5	70,5
	1298	65	77
	1400	71	84
	1502	76,2	90,2
	1604	82,2	97,2
	1706	87,4	104
	1808	93,4	111
1910	99,4	118	
2012	104	124	
2114	110	131	

P₂ Rated motor power output

(...) FK motor rated power output

H Total head in m

Tolerances according to UNI EN ISO 9906:2012

8SDS 70

Submersible borehole pumps for 8" wells



Characteristic curves, performance $n \approx 2900$ rpm, dimensions and weights

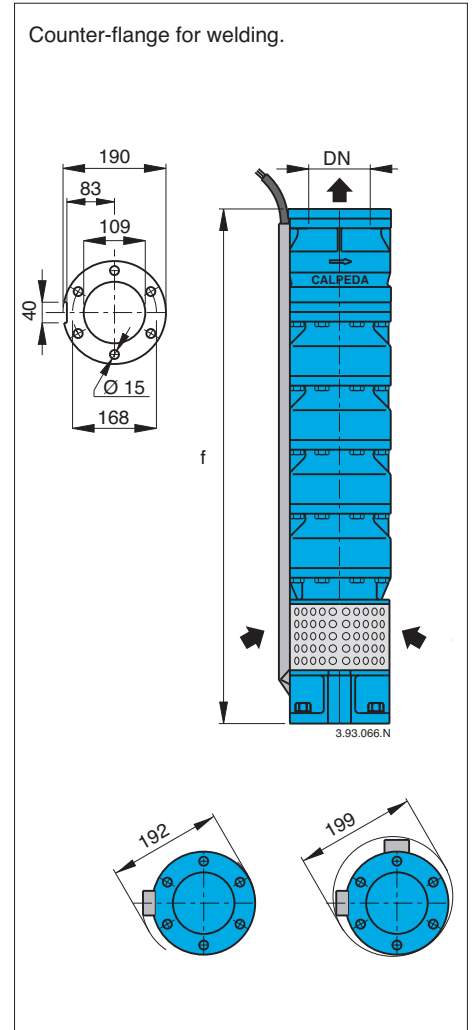
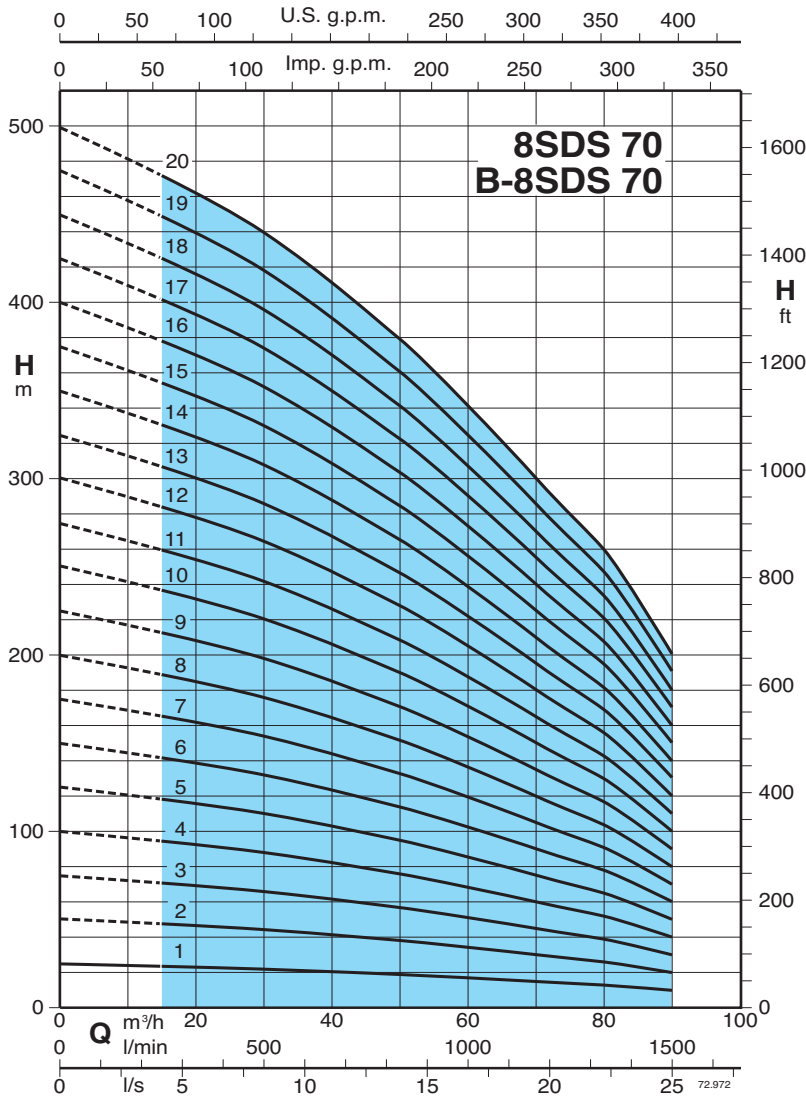

3 ~	P ₂		Q	n ≈ 2900 rpm																	
	kW	HP		H																	
				m ³ /h	20	30	40	50	60	70	80	90									
8SDS 70/1 - B-8SDS 70/1	5,5	7,5	23,5	23	22	20,5	19	17	15	13	10										
8SDS 70/2 - B-8SDS 70/2	9,2	12,5	47	46	44	41	38	34	30	26	20										
8SDS 70/3 - B-8SDS 70/3	15	20	70,5	69	66	61,5	57	51	45	39	30										
8SDS 70/4 - B-8SDS 70/4	18,5	25	94	92	88	82	76	68	60	52	40										
8SDS 70/5 - B-8SDS 70/5	22	30	118	115	110	102	95	85	75	65	50										
8SDS 70/6 - B-8SDS 70/6	26 (30)	35 (40)	141	138	132	123	114	102	90	78	60										
8SDS 70/7 - B-8SDS 70/7	30	40	165	161	154	143	133	119	105	91	70										
8SDS 70/8 - B-8SDS 70/8	37	50	188	184	176	164	152	136	120	104	80										
8SDS 70/9 - B-8SDS 70/9	45	60	212	207	198	184	171	153	135	117	90										
8SDS 70/10 - B-8SDS 70/10	45	60	235	230	220	205	190	170	150	130	100										
8SDS 70/11 - B-8SDS 70/11	51 (55)	70 (75)	259	253	242	225	209	187	165	143	110										
8SDS 70/12 - B-8SDS 70/12	55	75	282	276	264	246	228	204	180	156	120										
8SDS 70/13 - B-8SDS 70/13	59 (75)	80 (100)	306	299	286	266	247	221	195	169	130										
8SDS 70/14 - B-8SDS 70/14	59 (75)	80 (100)	329	322	308	287	266	238	210	182	140										
8SDS 70/15 - B-8SDS 70/15	66 (75)	90 (100)	353	345	330	307	285	255	225	195	150										
8SDS 70/16 - B-8SDS 70/16	75	100	376	368	352	328	304	272	240	208	160										
8SDS 70/17 - B-8SDS 70/17	75	100	400	391	374	348	323	289	255	221	170										
8SDS 70/18 - B-8SDS 70/18	92	125	423	414	396	369	342	306	270	234	180										
8SDS 70/19 - B-8SDS 70/19	92	125	447	437	418	389	361	323	285	247	190										
8SDS 70/20 - B-8SDS 70/20	92	125	470	460	440	410	380	340	300	260	200										

DN	Motor		f	8SDS	B-8SDS
	CS-R mm	FK mm			
100	145 6"	137 6"	602	38	43
			734	49	55,5
			866	60	68
			998	71,5	80,5
			1130	82,5	93
	1262	93,5	106		
	1394	105	118		
	1526	116	131		
	1658	127	143		
	1790	138	156		
191 8"	196 8"	1922	149	168	
		2054	160	181	
		2186	171	194	
		2318	182	206	
		2450	193	219	
2582	205	231			
2714	216	244			
2846	227	256			
2978	238	269			
3110	249	281			

P₂ Rated motor power output

(...) FK motor rated power output

H Total head in m

Tolerances according to UNI EN ISO 9906:2012

8SDS 100

Submersible borehole pumps for 8" wells



Characteristic curves, performance $n \approx 2900$ rpm, dimensions and weights

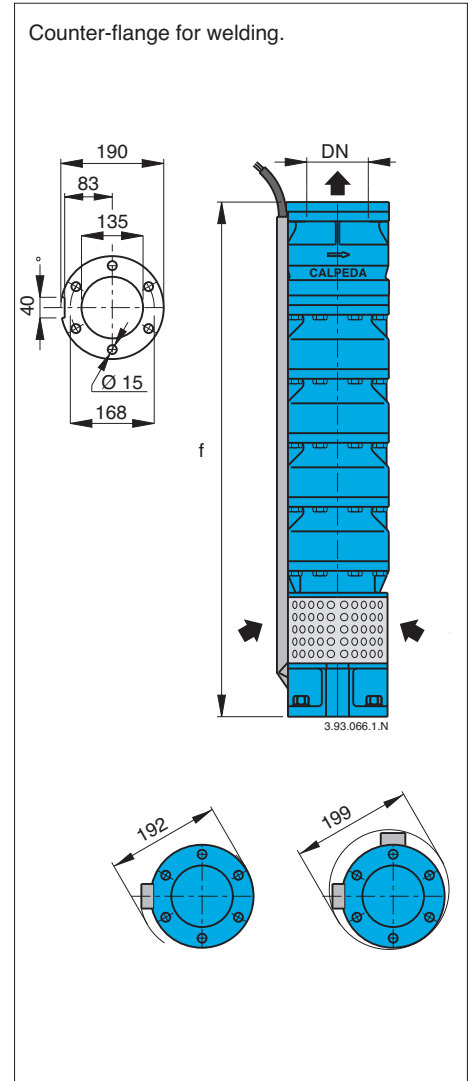
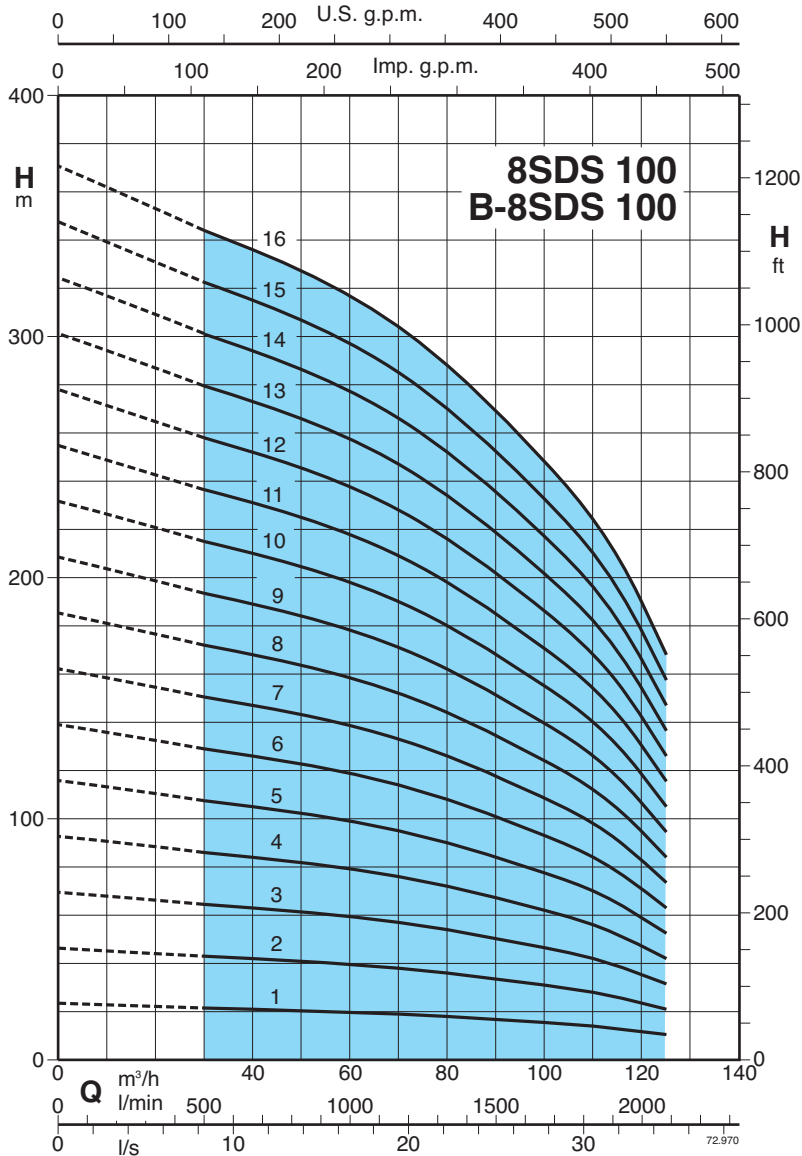

3 ~	P ₂		Q	n ≈ 2900 rpm											
	kW	HP		m ³ /h	30	40	50	60	70	80	90	100	110	125	
				l/min	500	666	833	1000	1166	1333	1500	1666	1833	2083	
8SDS 100/1 - B-8SDS 100/1	5,5	7,5	H m	21,5	21	20,5	20	19	18	17	15,5	14	10,5		
8SDS 100/2 - B-8SDS 100/2	11	15		43	42	41	40	38	36	34	31	28	21		
8SDS 100/3 - B-8SDS 100/3	18,5	25		64,5	63	61,5	60	57	54	51	46,5	42	31,5		
8SDS 100/4 - B-8SDS 100/4	22	30		86	84	82	80	76	72	68	62	56	42		
8SDS 100/5 - B-8SDS 100/5	30	40		107	105	102	100	95	90	85	77,5	70	52,5		
8SDS 100/6 - B-8SDS 100/6	37	50		129	126	123	120	114	108	102	93	84	63		
8SDS 100/7 - B-8SDS 100/7	45	60		150	147	143	140	133	126	119	108	98	73,5		
8SDS 100/8 - B-8SDS 100/8	45	60		172	168	164	160	152	144	136	124	112	84		
8SDS 100/9 - B-8SDS 100/9	51 (55)	70 (75)		193	189	184	180	171	162	153	139	126	94,5		
8SDS 100/10 - B-8SDS 100/10	55	75		215	210	205	200	190	180	170	155	140	105		
8SDS 100/11 - B-8SDS 100/11	66 (75)	90 (100)		236	231	225	220	209	198	187	170	154	115		
8SDS 100/12 - B-8SDS 100/12	66 (75)	90 (100)		258	252	246	240	228	216	204	186	168	126		
8SDS 100/13 - B-8SDS 100/13	75	100		279	273	266	260	247	234	221	201	182	136		
8SDS 100/14 - B-8SDS 100/14	92	125		301	294	287	280	266	252	238	217	196	147		
8SDS 100/15 - B-8SDS 100/15	92	125		322	315	307	300	285	270	255	232	210	157		
8SDS 100/16 - B-8SDS 100/16	92	125		344	336	328	320	304	288	272	248	224	168		

DN	Motor		f	8SDS	B-8SDS
	CS-R mm	FK mm			
125	145 6"	137 6"	602	38	43
			734	49	55
			866	59	67
			998	70	79
			1130	81	91
			1262	92	103
	191 8"	196 8"	1394	102	115
			1526	113	128
			1658	124	140
			1790	135	152
			1922	145	164
			2054	156	176
			2186	167	188
			2318	177	200
			2450	188	212
			2582	199	224

P₂ Rated motor power output

(...) FK motor rated power output

H Total head in m

Tolerances according to UNI EN ISO 9906:2012

8SDS 150

Submersible borehole pumps for 8" wells



Characteristic curves, performance $n \approx 2900$ rpm, dimensions and weights

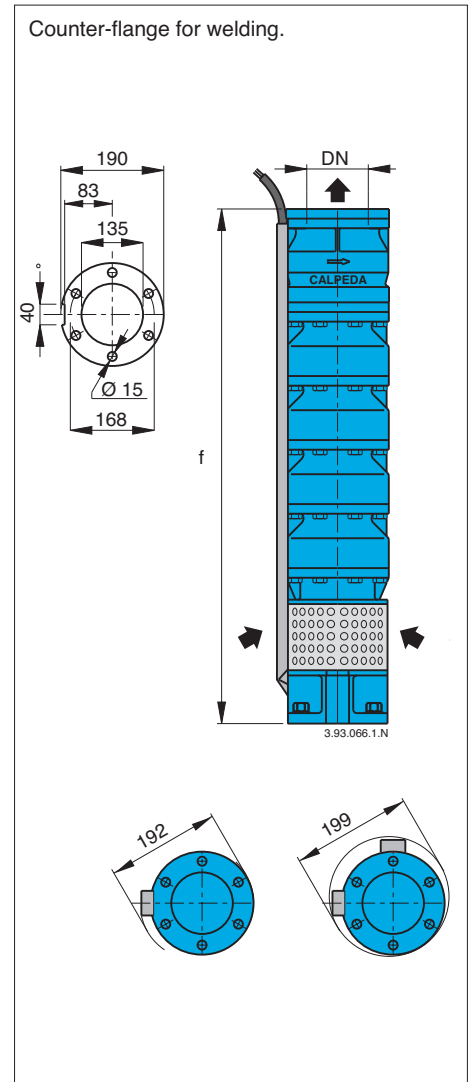
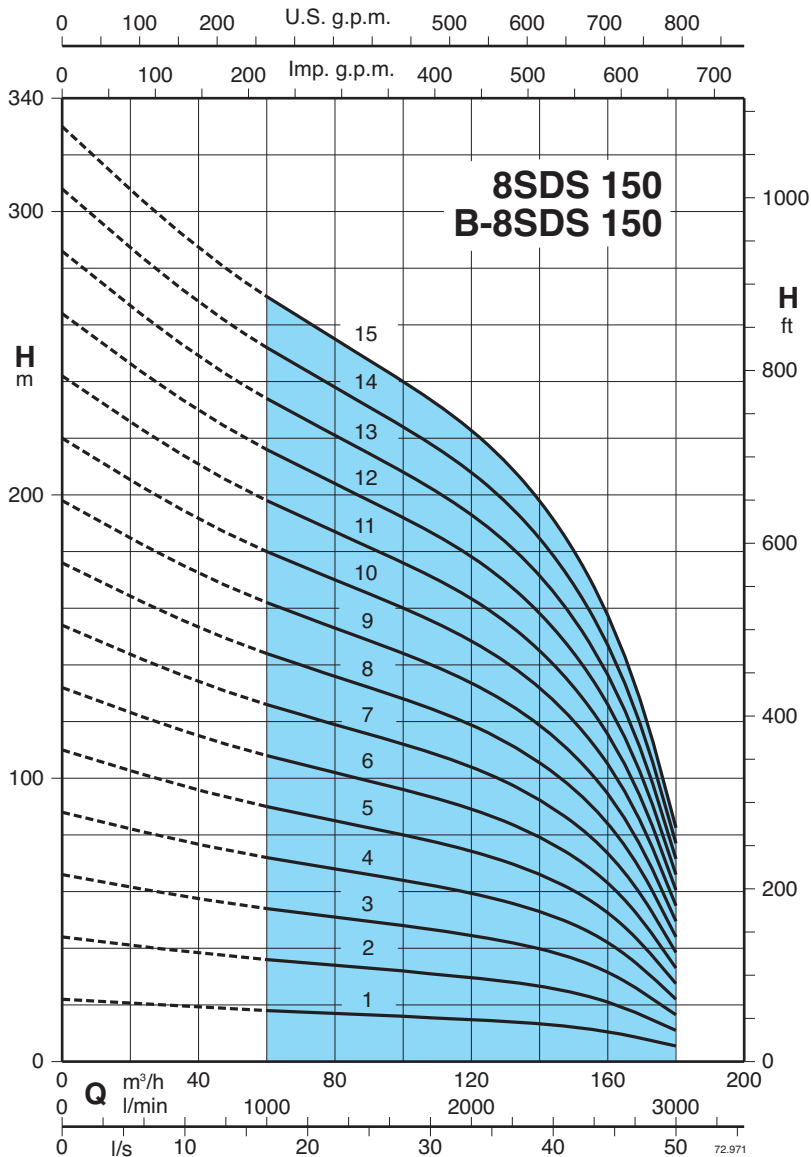

3 ~	P2		Q	$n \approx 2900$ rpm												DN	Motor		f	8SDS	B-8SDS	
	kW	HP		m³/h	$n \approx 2900$ rpm												CS-R	FK				
					l/min	60	70	80	90	100	110	125	140	150	160							180
8SDS 150/1 - B-8SDS 150/1	7,5	10	H m	18	17,5	17	16,5	16	15,5	14,5	13	11,5	10,5	5,5	125	145 6"	137 6"	602	38	43		
8SDS 150/2 - B-8SDS 150/2	15	20		36	35	34	33	32	31	29	26	23	21	11				734	49	55,5		
8SDS 150/3 - B-8SDS 150/3	22	30		54	52,5	51	49,5	48	46,5	43,5	39	34,5	31,5	16,5				866	60	68		
8SDS 150/4 - B-8SDS 150/4	30	40		72	70	68	66	64	62	58	52	46	42	22				998	71,5	80,5		
8SDS 150/5 - B-8SDS 150/5	37	50		90	87,5	85	82,5	80	77,5	72,5	65	57,5	52,5	27,5				1130	82,5	93		
8SDS 150/6 - B-8SDS 150/6	45	60		108	105	102	99	96	93	87	78	69	63	33				1262	93,5	106		
8SDS 150/7 - B-8SDS 150/7	51 (55)	70 (75)		126	122	119	115	112	108	101	91	80,5	73,5	38,5		1394	105	118				
8SDS 150/8 - B-8SDS 150/8	59 (75)	80 (100)		144	140	136	132	128	124	116	104	92	84	44		1526	116	131				
8SDS 150/9 - B-8SDS 150/9	66 (75)	90 (100)		162	157	153	148	144	139	130	117	103	94,5	49,5		1658	127	143				
8SDS 150/10 - B-8SDS 150/10	75	100		180	175	170	165	160	155	145	130	115	105	55		1790	138	156				
8SDS 150/11 - B-8SDS 150/11	92	125		198	192	187	181	176	170	159	143	126	115	60,5		1922	149	168				
8SDS 150/12 - B-8SDS 150/12	92	125		216	210	204	198	192	186	174	156	138	126	66		2054	160	181				
8SDS 150/13 - B-8SDS 150/13	110	150		234	227	221	214	208	201	188	169	149	136	71,5		2186	171	194				
8SDS 150/14 - B-8SDS 150/14	110	150		252	245	238	231	224	217	203	182	161	147	77		2318	182	206				
8SDS 150/15 - B-8SDS 150/15	110	150		270	262	255	247	240	232	217	195	172	157	82,5		2450	193	219				

P2 Rated motor power output

(...) FK motor rated power output

H Total head in m

Tolerances according to UNI EN ISO 9906:2012

10SDS 160

Submersible borehole pumps for 10" wells



Characteristic curves, performance $n \approx 2900$ rpm, dimensions and weights

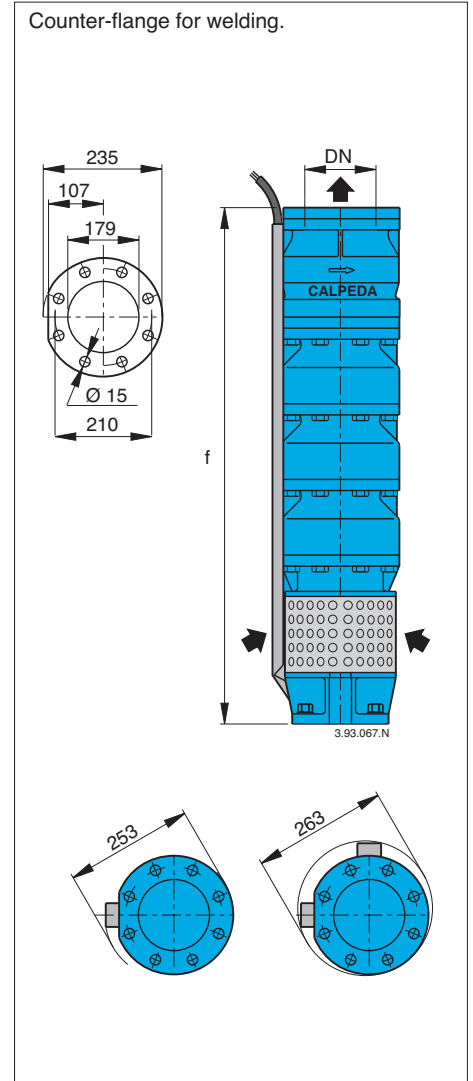
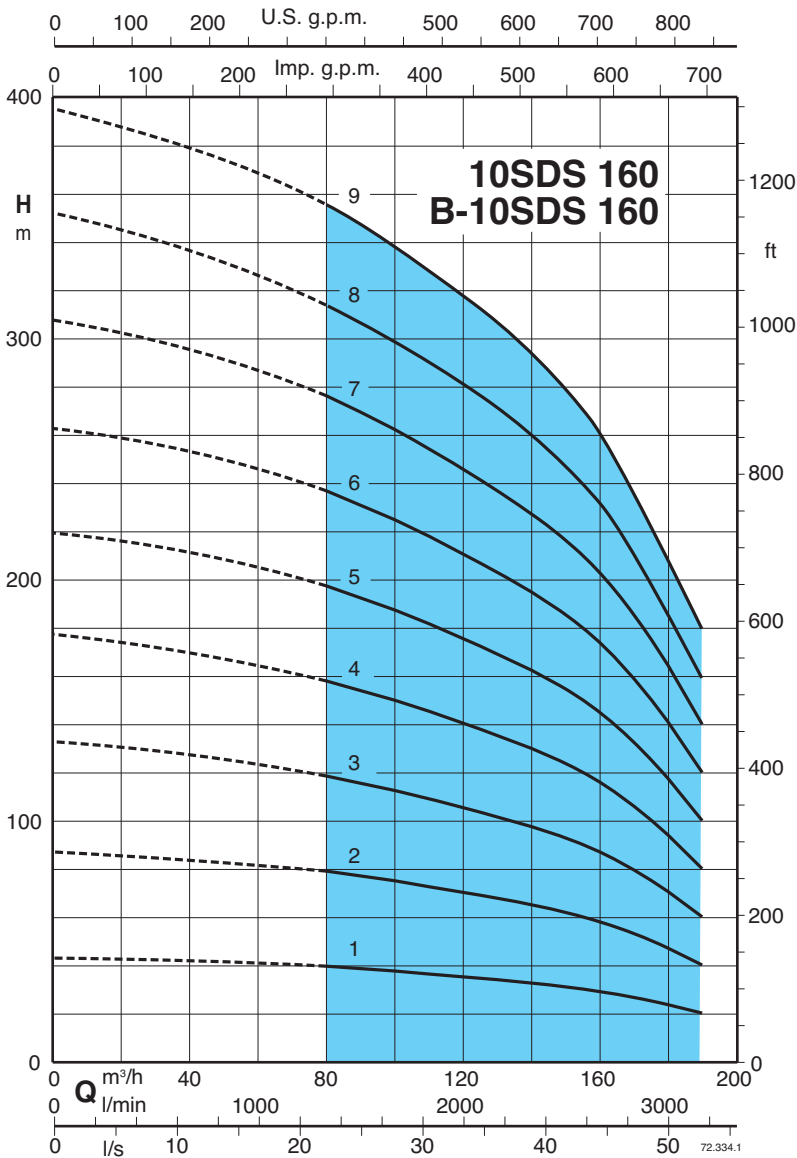

3 ~	P ₂		Q	n ≈ 2900 rpm												DN	Motor		f	10SDS	B-10SDS			
	kW	HP		m³/h	80	90	100	110	125	140	150	160	170	180	190		CS-R	FK				mm	kg	kg
					l/min	1333	1500	1666	1833	2083	2333	2500	2666	2833	3000		3166	mm						
10SDS 160/1 - B-10SDS 160/1	18,5	25	H m	39,5	38	37,5	36	34,5	32,5	31	29	26,5	22	20	175	145 6"	137 6"	865	77	87				
10SDS 160/2 - B-10SDS 160/2	37	50		78,5	76,5	74,5	72,5	69	65	62	58,5	53,5	44	40				1035	103	114				
10SDS 160/3 - B-10SDS 160/3	55	75		118	114	112	108	104	98	92,5	87,5	80	66,5	60		191 8"	196 8"	1205	126	141				
10SDS 160/4 - B-10SDS 160/4	75	100		157	153	149	145	138	130	123	117	107	88,5	80				1375	150	169				
10SDS 160/5 - B-10SDS 160/5	92	125		196	191	186	181	173	163	154	146	134	111	100		240 10"	-	1545	173	195				
10SDS 160/6 - B-10SDS 160/6	110	150		236	229	224	217	207	195	185	175	160	133	120				1715	197	222				
10SDS 160/7 - B-10SDS 160/7	130	175		275	267	261	253	242	228	216	204	187	155	140				1885	220	249				
10SDS 160/8 - B-10SDS 160/8	150	200		314	305	298	289	276	260	246	233	213	177	160		2055	244	276						
10SDS 160/9 - B-10SDS 160/9	185	250		356	342	338	324	311	293	279	261	239	198	180		2225	268	303						

P₂ Rated motor power output

(...) FK motor rated power output

H Total head in m

Tolerances according to UNI EN ISO 9906:2012

10SDS 190

Submersible borehole pumps for 10" wells



Characteristic curves, performance $n \approx 2900$ rpm, dimensions and weights

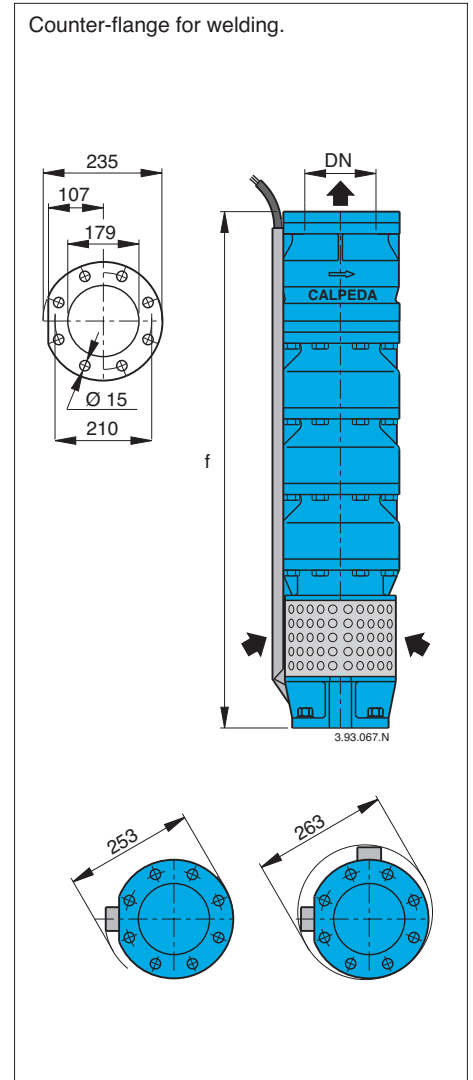
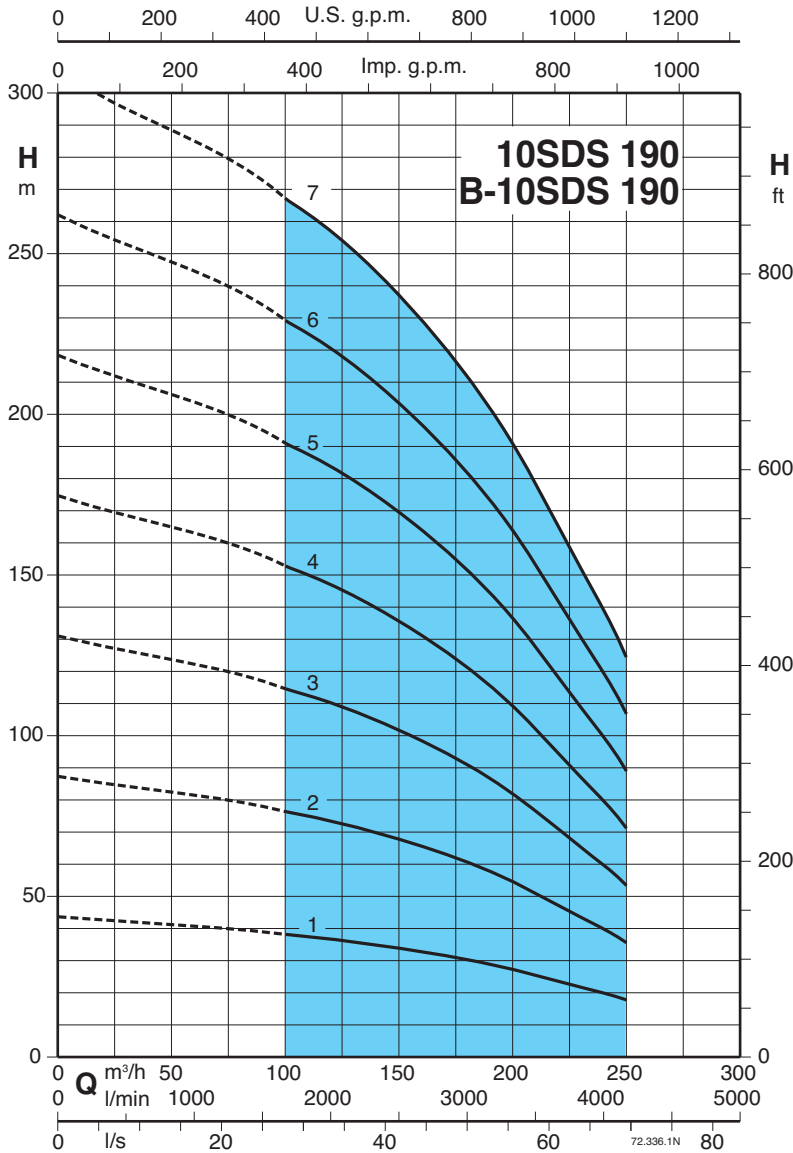

3 ~	P2		Q	$n \approx 2900$ rpm											DN	Motor		f	10SDS	B-10SDS
	kW	HP		$n \approx 2900$ rpm												CS-R	FK			
			m³/h	100	120	140	160	180	200	220	230	240	250	mm						
			l/min	1666	2000	2333	2666	3000	3333	3666	3833	4000	4166							
10SDS 190/1 - B-10SDS 190/1	22	30	H m	38	37	35	33	30	27	24	22	20	18	175	145 6"	137 6"	865	78	88	
10SDS 190/2 - B-10SDS 190/2	45	60		76	73	70	66	61	55	47	44	40	36				1035	102	115	
10SDS 190/3 - B-10SDS 190/3	66 (75)	90 (100)		115	110	105	98	91	82	71	65	59	53				1205	127	143	
10SDS 190/4 - B-10SDS 190/4	92	125		153	147	140	131	121	109	95	87	79	71				1375	151	170	
10SDS 190/5 - B-10SDS 190/5	110	150		191	183	175	164	152	137	119	109	99	89				1545	175	198	
10SDS 190/6 - B-10SDS 190/6	130	175		229	220	210	197	182	164	142	131	119	107				1715	199	225	
10SDS 190/7 - B-10SDS 190/7	185	250		267	257	244	230	212	191	166	152	139	125				1885	223	252	

P2 Rated motor power output

(...) FK motor rated power output

H Total head in m

Tolerances according to UNI EN ISO 9906:2012

10SDS 280

Submersible borehole pumps for 10" wells



Characteristic curves, performance $n \approx 2900$ rpm, dimensions and weights

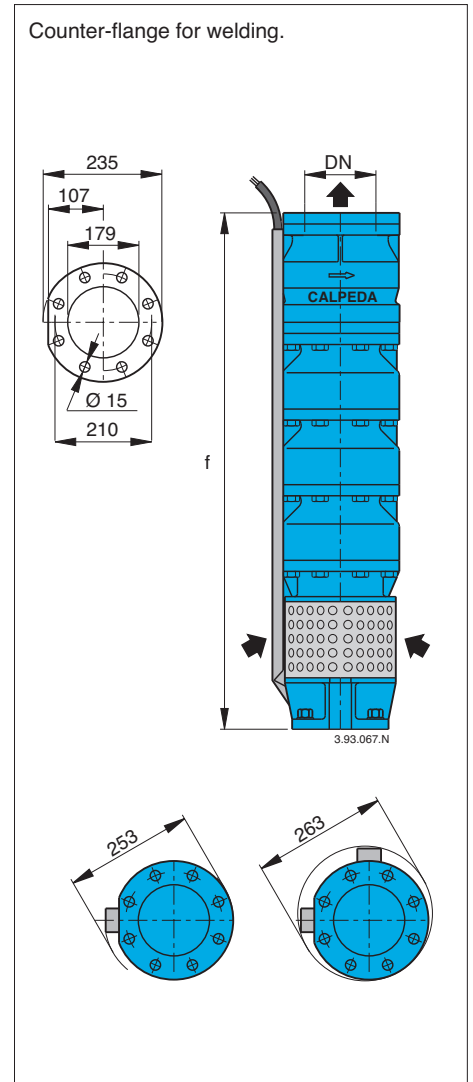
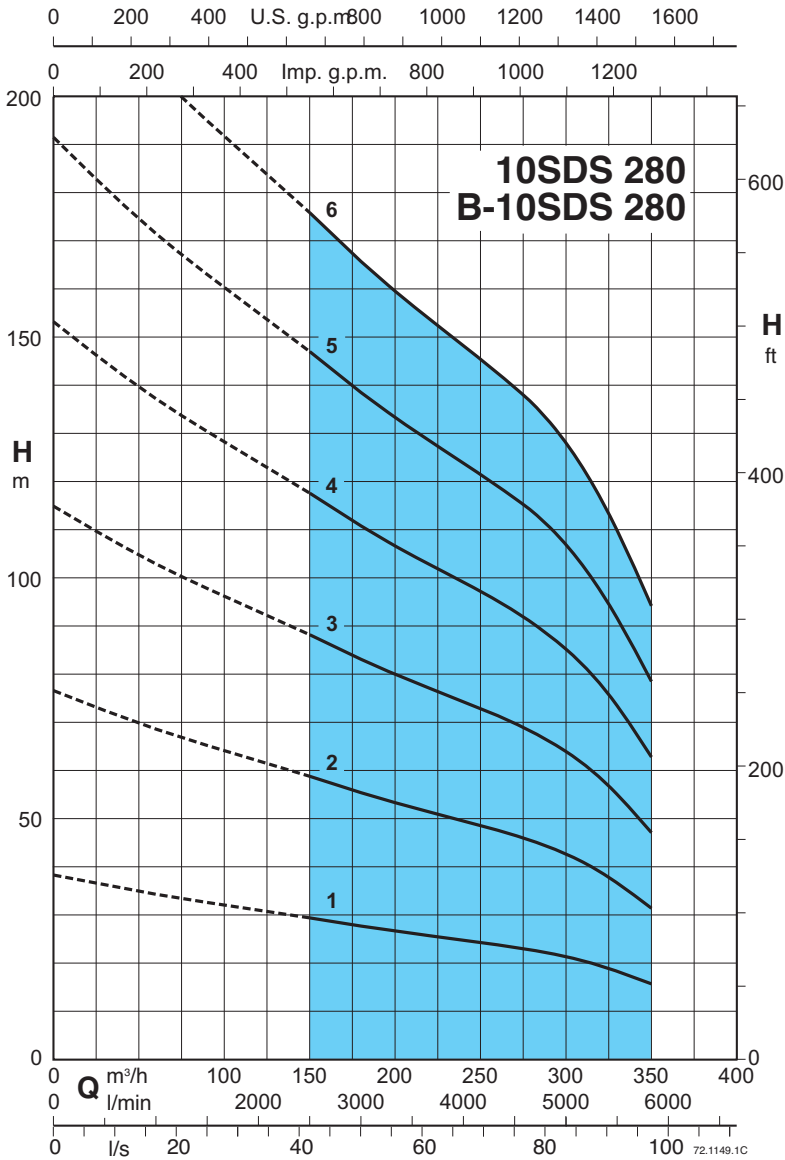

3 ~	P ₂		Q	n ≈ 2900 rpm											DN	Motor		f	10SDS	B-10SDS
	kW	HP		m ³ /h	150	180	200	220	240	260	280	300	315	350		CS-R	FK			
			l/min	2500	3000	3333	3666	4000	4333	4666	5000	5250	5833	mm		mm				
10SDS 280/1 - B-10SDS 280/1	26 (30)	35 (40)	H m	29	28	27	26	25	24	23	21	20	16	175	145-6"	137-6"	865	78	88	
10SDS 280/2 - B-10SDS 280/2	55	75		59	55	53	51	50	48	46	42	40	31		191	196	8"	1035	103	116
10SDS 280/3 - B-10SDS 280/3	75	100		88	83	80	77	75	71	69	64	60	47		8"		1205	127	143	
10SDS 280/4 - B-10SDS 280/4	110	150		118	111	106	103	100	95	92	85	80	63		240		10"	1375	151	170
10SDS 280/5 - B-10SDS 280/5	130	175		147	139	133	129	125	119	115	106	100	79		10"	8"	1545	175	198	
10SDS 280/6 - B-10SDS 280/6	150	200		176	167	160	155	150	143	138	127	120	95				1715	199	226	

P₂ Rated motor power output

(...) FK motor rated power output

H Total head in m

Tolerances according to UNI EN ISO 9906:2012

Cables connection kit

It allows connection of electric cables with junction submerged in water.

The kit includes:

- 4 connectors
- 4 shrink-sheaths for protection of individual wires
- 1 shrink-sheath for protection of the 4-pole wire.

The sheath shrinks with heating (flame or drier) which causes resin outlet granting connection waterproofing.



Installation examples

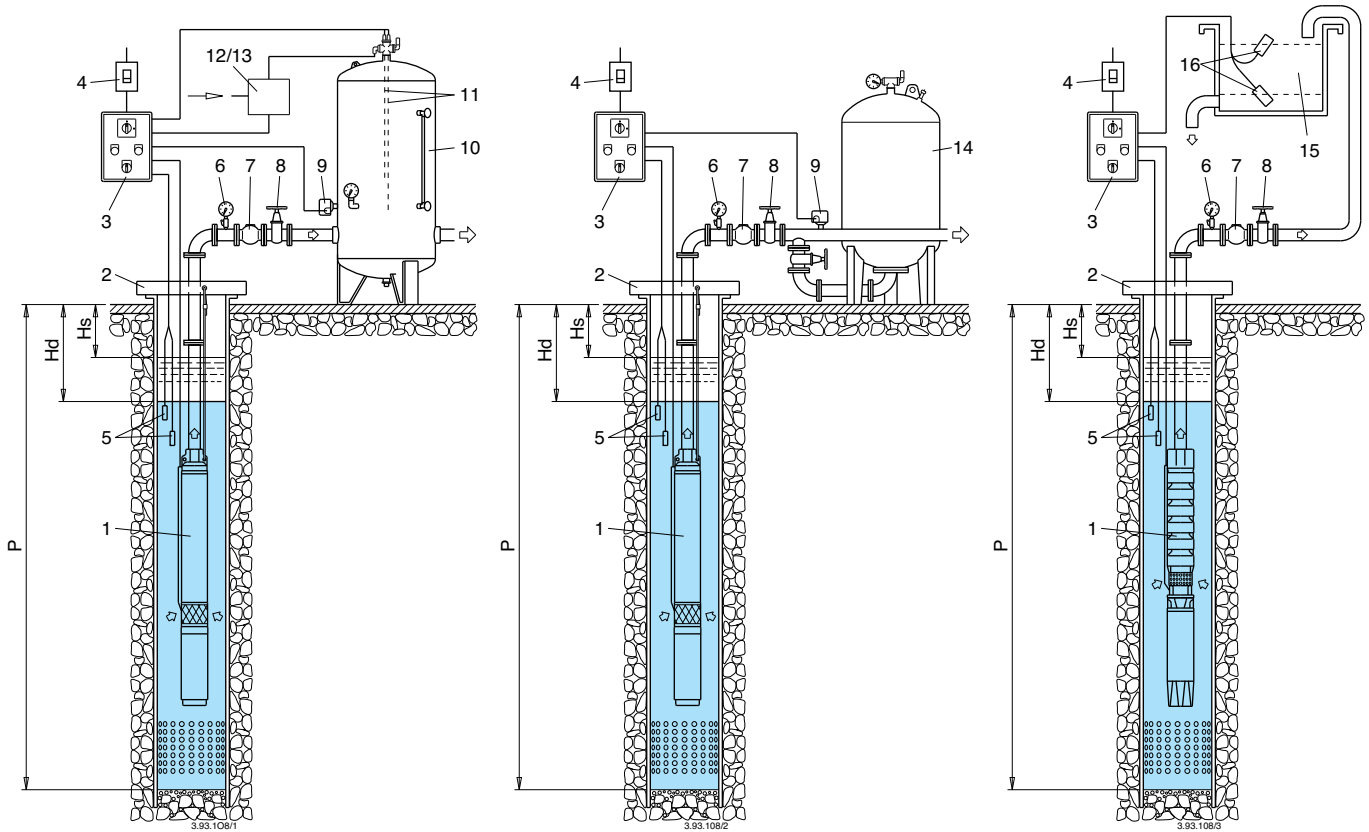

- 1 Submersible pump
- 2 Pump support system
- 3 Electric control board
- 4 Circuit breaker
- 5 Minimum level probes
- 6 Pressure gauge
- 7 Check valve
- 8 Throttle gate valve
- 9 Pressure switch
- 10 Pressure tank
- 11 Probes for air entry control
- 12 Electric valve
- 13 Compressor
- 14 Membrane tank
- 15 Storage tank
- 16 Start-stop probes

Hs Static level
Hd Dynamic level
P Tubewell depth